



DOMESTIC FANS RANGE

Domestic Ceiling Fans

The Ceiling Fan range from SRK Impex incorporating power, aesthetics and sheer comfort.

At the same time providing comfort, safety and durability that are the trademarks of every SRK Impex product.

The aerodynamically designed blades ensure maximum air thrust.

These fans are available in attractive colours, shades & decorative add-ons that will complement any decor.

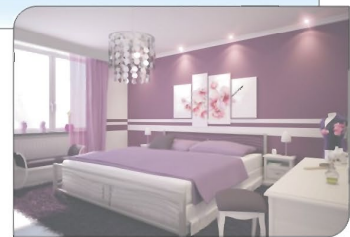
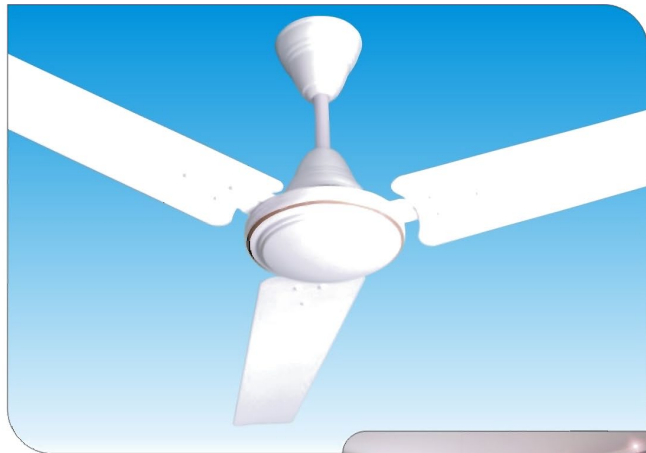

Domestic Table Fans

SRK Impex brings to you a range of elegant & innovative table fans in sheet metal body. Stylish, powerful & with a host of dynamic features, these fans are sure to find a place in your homes and working environment.

The sophisticated, elegant looks and beautiful colours of the SRK Impex table fans are sure to enhance any decor.

Wall Mounted & Pedestal Fans are also available.

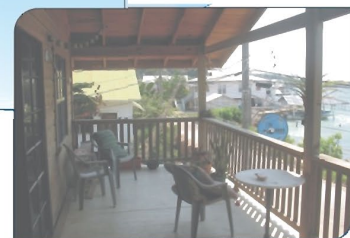

TECHNICAL SPECIFICATIONS:

Sweep (in mm)	Speed (in RPM)	Air Delivery (Cu. Mtr/min)	Input Power (in Watts)
400	1400	70	55

Domestic & Industrial Fans

SRK Impex

Tel/fax : +91 22 21731008 | Mob : +91 98204 51599, +91 93737 51599 | email : srk@srkimpex.co.in | skype : srk.srkimpex
Address : F8 Niharika Plaza, Gladys Alwares Road, Off Pokhran Road No.2, Thane west - 400610. India



DOMESTIC FANS RANGE

Domestic Exhaust Fans

PREMIUM DOMESTIC EXHAUST FAN

A continuous duty, double ball bearing, hub design, domestic fresh air/exhaust fan.

Sweep : 225mm, 300mm

Bird screen for protection against birds and foreign matter.

Reversible version is available from exhaust to fresh air mode.

TECHNICAL SPECIFICATIONS:

Sweep (in mm)	Speed (in RPM)	Air Delivery (Cu. Mtr/hr)	Input Power (in Watts)
225 mm(9")	2200	1200	70
225 mm(9")	1400	720	45
300 mm(12")	1400	1600	70

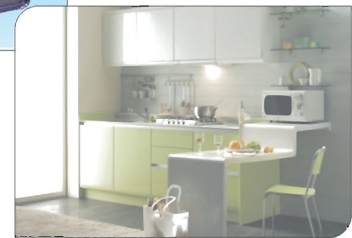

CLASSIC DOMESTIC EXHAUST FAN

3 Blades light duty economically designed domestic exhaust fan.

Suitable for continuous running.

Ideal for small living rooms & enclosed work places.

Die cast aluminium body.

Fitted with 2 self aligned bush bearings for smooth operation and with Bird Guard for safety.

Sweep : 225mm, 300mm

Classic models are also available in Hub Design blades for economical options.

TECHNICAL SPECIFICATIONS:

Sweep (in mm)	Speed (in RPM)	Air Delivery (Cu. Mtr/hr)	Input Power (in Watts)
225 mm(9")	2200	900	70
225 mm(9")	1400	600	45
300 mm(12")	1350	1400	65

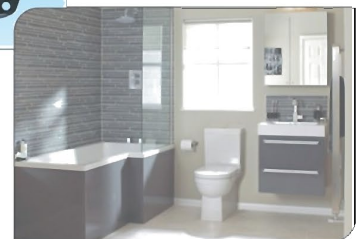

Domestic & Industrial Fans

SRK Impex

Tel/fax : +91 22 21731008 | Mob : +91 98204 51599, +91 93737 51599 | email : srk@srkimpex.co.in | skype : srk.srkimpex
Address : F8 Niharika Plaza, Gladys Alwares Road, Off Pokhran Road No.2, Thane west - 400610. India



INDUSTRIAL FANS RANGE

Heavy Duty Air Circulator Fans

FEATURES

- Aerodynamically designed blades for higher air delivery and minimum noise level.
- Dynamic balancing of blades.
- Adjustable height for Pedestal model.
- Indexable to different positions upto 360°
- Oscillation to 85° for total flexibility.
- Sturdy finger proof brazed wire powder coated guards.
- Robust base to ensure absolute stability.
- Power consumption limited to bare minimum.
- Generally conforming to IS:2997-1964.
- IEC approved product can be supplied.

APPLICATIONS

- Airports
- Bus Depots
- Factories
- Offices
- Theaters
- Pandal Decorators
- Heat Treatment Shops
- Auditoriums
- Conference Halls
- Shops
- Restaurants
- Public Places
- Railway Stations

SPECIFICATIONS

- Fan Sweep :** 450 mm (18"). 600 mm (24")
750 mm (30"). 900 mm (36")
- Fan Motor :** 4 pole (Standard) 6 pole (Optional),
1 Phase Cap start & run or
3 Phase induction motor.

POWER SUPPLY

- Standard :** 220/250 V, Single Phase 50 Hz
380/440 V, Three Phase 50 Hz
- Optional :** 110 V/60 Hz, 230 V/60 Hz

FINISH

- Standard :** Epoxy powder coating in metallic shades.
- Option :** Optional Colour available.
- Bearings :** 6202 ZZ (V3C3) Ball Bearings.

DIMENSIONAL SPECIFICATIONS:

Size	A	B	H		D		WEIGHT Kgs	
			MIN	MAX	MIN	MAX	PED.	WALL
450	450	280	1030	1320	230	510	20.0	18.0
600	600	660	1300	1550	300	630	26.0	24.0
750	750	660	1330	1610	330	630	28.0	26.0

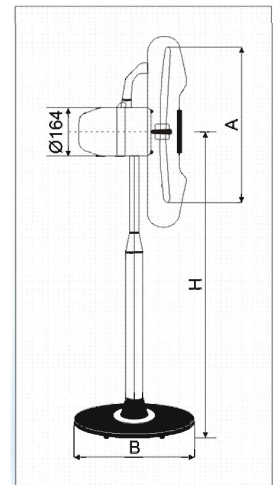
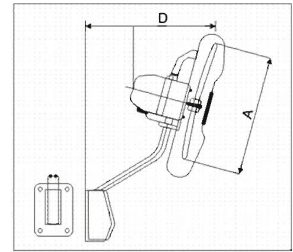

Domestic & Industrial Fans

SRK Impex

Tel/fax : +91 22 21731008 | Mob : +91 98204 51599, +91 93737 51599 | email : srk@srkimpex.co.in | skype : srk.srkimpex
Address : F8 Niharika Plaza, Gladys Alwares Road, Off Pokhran Road No.2, Thane west - 400610. India



INDUSTRIAL FANS RANGE

HEAVY DUTY AIR CIRCULATOR FANS PERFORMANCE

Size	Phase	Speed (in RPM)	Current (in AMP)	Power Input (in Watts)	Air Delivery (in Cu. Mtr/hr)	Peak Air Velocity (M/min)	Adjustable Height (M)	Noise Level (DBA)
450	Single	1450	0.45	100	8000	250	1.40/1.00	64
600	Single	1430	0.95	200	15000	250	1.65/1.40	68
750	Single	1430	1.5	320	23000	250	1.95/1.50	74
600	Three	1430	0.40	180	15000	250	1.65/1.40	68
750	Three	1430	0.70	300	23000	250	1.95/1.50	74

Heavy Duty Exhaust Fans

FEATURES

Wide range of sweeps to choose from, with suitability for single or three phase AC supply.

Reversibility by change of blade mounting.

Metal frame with rubber mounting for silent operation.

Al-extruded section motor body for higher heat dispersion area to control the temperature rise with in motor body for effective working of motor.

Heavy duty, totally enclosed, energy efficient, 2 ball bearing induction motors.

Precisely balanced aerodynamically contoured metal blades with die cast aluminium spider/hub.

Long lasting Epoxy powder coating.

Availability of accessories like front back protection guard for safety and square gravity louvers.

Generally conforming to IS:2312-1967.

Also supply IEC approved product.

APPLICATIONS

Factories Warehouses
 Chemical and Pharmaceutical Industries
 Hotels Theatres and Auditoriums
 Paint shops Dairies & Food Processing Units
 The Exhaust Fans are also used as a standard equipment in Desert Coolers, Paint Booths, Welding, Transformers etc.

SPECIFICATIONS

Fan Sweep : 300 mm (12"), 380 mm (15")
 450 mm (18") and 600 mm (24")

Fan Motor : 4, 6 or 8 pole,
 1 Phase, Cap Start & run or
 3 Phase Induction motor



POWER SUPPLY

Standard : as under

220/250 V, Single Phase 50 Hz
 380/440 V, Three Phase 50 Hz

Optional : 220 /250 V, Single Phase 60 Hz
 380 /440 V, Single Phase 60 Hz
 110 V, Single Phase 50 / 60 Hz

FINISH

Standard : Epoxy powder coating Military Green.

Option : Optional Colour, MOQ-200 nos.

Bearings : Double sealed (ZZ) Ball Bearings.

Domestic & Industrial Fans

SRK Impex

Tel/fax : +91 22 21731008 | Mob : +91 98204 51599, +91 93737 51599 | email : srk@srkimpex.co.in | skype : srk.srkimpex
 Address : F8 Niharika Plaza, Gladys Alwares Road, Off Pokhran Road No.2, Thane west - 400610. India



ECONOMY FANS RANGE

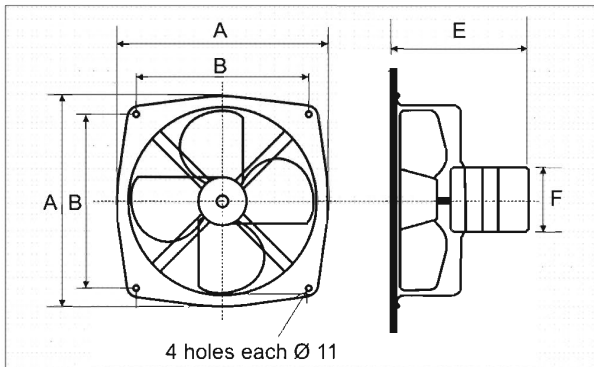

Cat. Ref	EF 300	EF 380	EF 450	EF 600
Sweep (mm)	300	380	450	600
Inch (")	(12)	(15)	(18)	(24)
Poles	4	4	6	4
Supply	1 3	1 3	1 3	1 3

PERFORMANCE

Cat. Ref	Rating		Performance				
	Pole	Phase	Speed (RPM)	Input (Watts)	Air Delivery (Cu. mtr/hr)	Current (AMP)	Sound Level (DBA)
EF 300	4	1	1400	90	2000	0.40	65
	4	1 3	1400	150	4000	0.70 0.35	60
EF 380	6	1 3	950	100	2300	0.46 0.23	65
	EF 450	4	1 3	1400	370	6200	1.70 0.85
6		1 3	950	150	4340	0.70 0.35	60
EF 600	6	1 3	950	500	10400	2.35 1.16	70
	8	1 3	700	260	6150	1.20 0.60	65

Cat. Ref	Poles	Dimensions (in mm)					Nett Weight Kg.
		A	B	C	E	F	
EF 300	4	395	305	325	250	105	4.00
EF 380	4	485	375	405	285	105	8.00
	6						
EF 450	4	555	450	475	315	105	9.00
	6						
EF 600	6	730	600	635	355	130	20.00
	8						

Classic Pedestal Fans

Aerodynamically designed sheet metal blade for maximum air flow with power saving.

Maximum air thrust.

Powerful motor with 3 speed control.

High torque gear box.

Robust and cost effective.

Adjustable Height in pedestal fan.

APPLICATIONS

Ventilating stores	Offices
Factories	Shops
Malls	Showrooms
Foam buildings	Pandals etc

TECHNICAL SPECIFICATIONS:

Sweep (in mm)	Speed (in RPM)	Air Delivery (Cu. Mtr/hr)	Input Power (in Watts)
600 mm(24")	1400	9000	150
500 mm(20")	1400	7800	130
450 mm(18")	1400	6500	105

Economical Heavy Duty Exhaust Fans & FHP Motors as per customer requirement are also available

